



# Changes to the 2020 National Electrical Code



Life Is On



[se.com/us](https://se.com/us)

# Table of contents



## CHAPTER 1

# Introduction

Chapter 1 provides an overview of the National Electrical Code® (NEC), including:

- How the code is updated
- How often codes change
- Who these changes impact

### The purpose of this e-guide

This e-guide offers a review and analysis of the key changes for dwellings in the 2020 NEC.

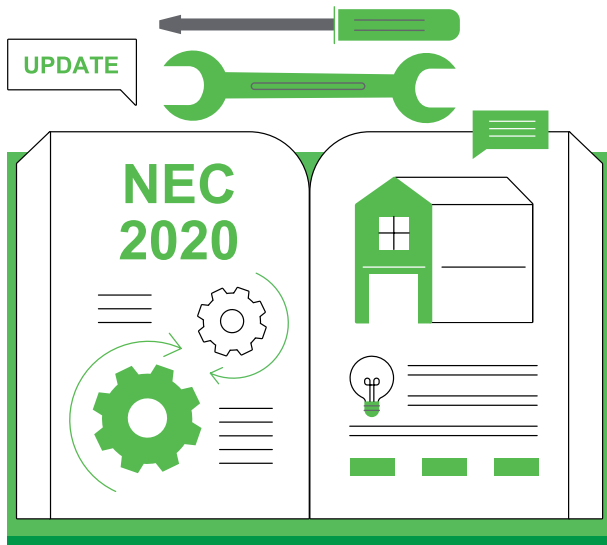

## A brief history of the NEC

The National Electrical Code, published by the National Fire Protection Association (NFPA), is a set of standards meant to ensure safe installation of electrical equipment in the U.S.

The NEC was first published in 1897 and is revised every three years. The 2020 edition of the NEC debuted in September 2019.

States and local jurisdictions independently determine when they will adopt a new NEC edition. Once it is locally adopted, electrical contractors and the authority having jurisdiction are responsible for ensuring compliance with the new set of requirements.

The 2020 NEC offers numerous changes that affect residential electrical installations. The code refers to these types of structures as single-family, two-family, or multi-family dwelling units.

“

*The practical safeguarding of persons and property from hazards arising from the use of electricity.*”

— Section 90.1, Code Purpose

Let's first review the new and revised definitions that impact residential installations.

## CHAPTER 2

# Changing definitions

In this chapter, we highlight four new and revised definitions for residential installations.

# Changing definitions



## Habitable room

Per Article 100, “**habitable rooms**” are used for living, sleeping, eating, or cooking. This term excludes bathrooms, toilet rooms, closets, hallways, storage or utility spaces, and similar areas.



## Laundry area

Per Article 100, “**laundry areas**” contain or are designed to contain a laundry tray, clothes washer, or clothes dryer.



---

Next, let's discuss the new branch circuit requirements.

## Reconditioned

The new term in Article 100 defines “**reconditioned**” as electromechanical systems, equipment, apparatus, or components that are restored to operating conditions.

Reconditioning is not the same as normal servicing of equipment that, once serviced, remains within a facility. Additionally, the replacement of listed equipment on a one-to-one basis does not constitute reconditioned equipment.

## Receptacle

“**Receptacle**” is defined as a contact device installed at an outlet for the connection of an attachment plug, or for the direct connection of electrical utilization equipment designed to mate with the corresponding contact device.

A receptacle is a single contact device with no other contact device on the same yoke or strap. A multiple receptacle is two or more contact devices on the same yoke or strap.



## CHAPTER 3

# Branch circuit requirements

In this chapter, we explore the expanded GFCI protections and requirements for countertops and work surfaces.



# Branch circuit requirements

## GFCI protection

The 2020 NEC expands GFCI protection to 250-volt receptacles. Now, all 125-volt through 250-volt receptacles supplied by a single-phase branch circuit rated 150 volts-to-ground or less and located in certain locations must have GFCI protection.

This includes receptacles in the following locations:

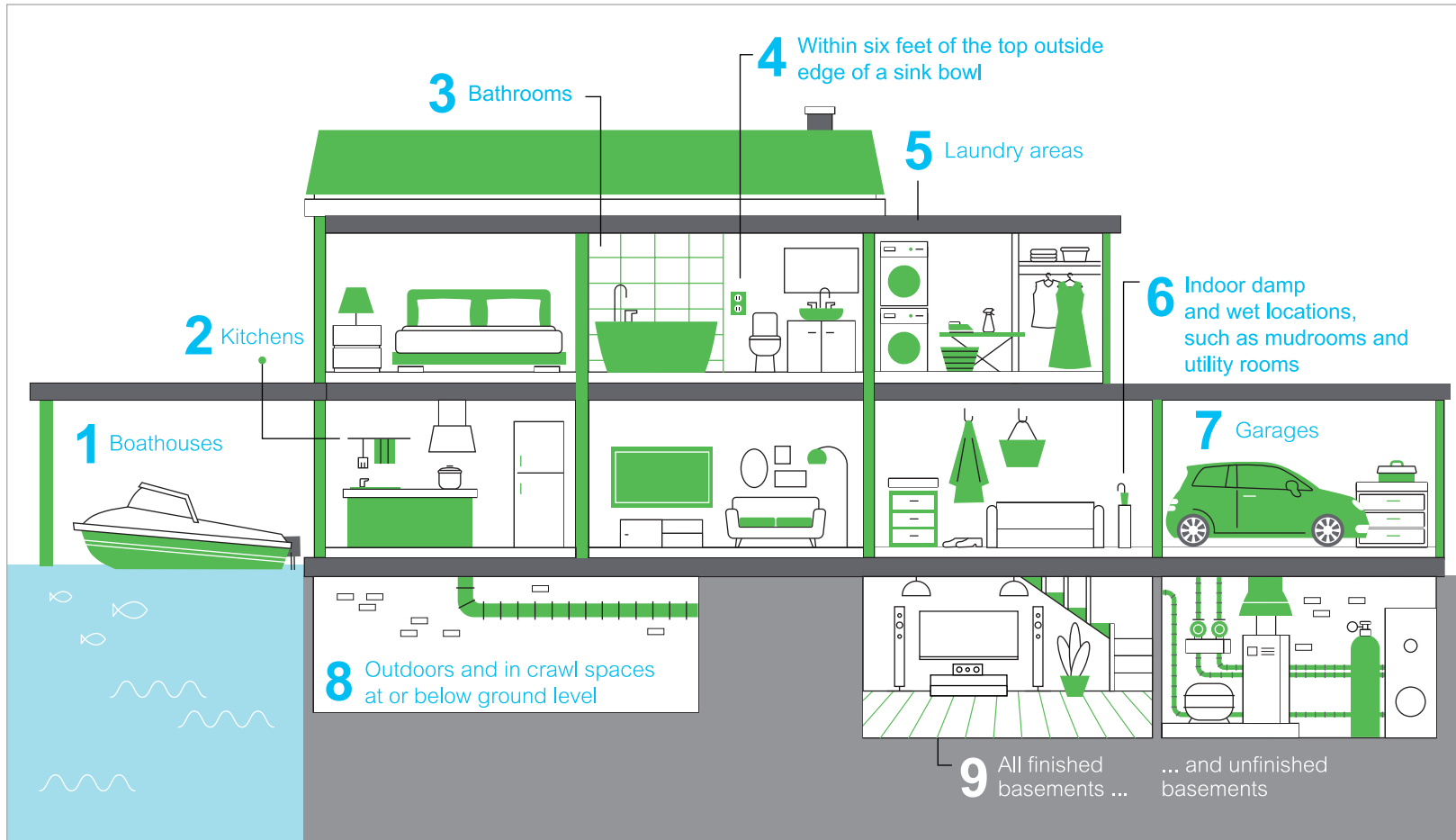

# Branch circuit requirements

## GFCI protection for countertops and work surfaces

Subsection 210.52(C)(2) outlines new requirements for receptacles installed at countertops and work surfaces.

First, at least one receptacle outlet is required for the first nine square feet, or fraction thereof, of countertop or work surface area. An additional receptacle outlet must then be installed for each 18 square feet, or fraction thereof, for the remaining countertop or work surface area.

The second part of the code requires one receptacle outlet located within two feet of the outer end of a peninsular countertop or work surface.

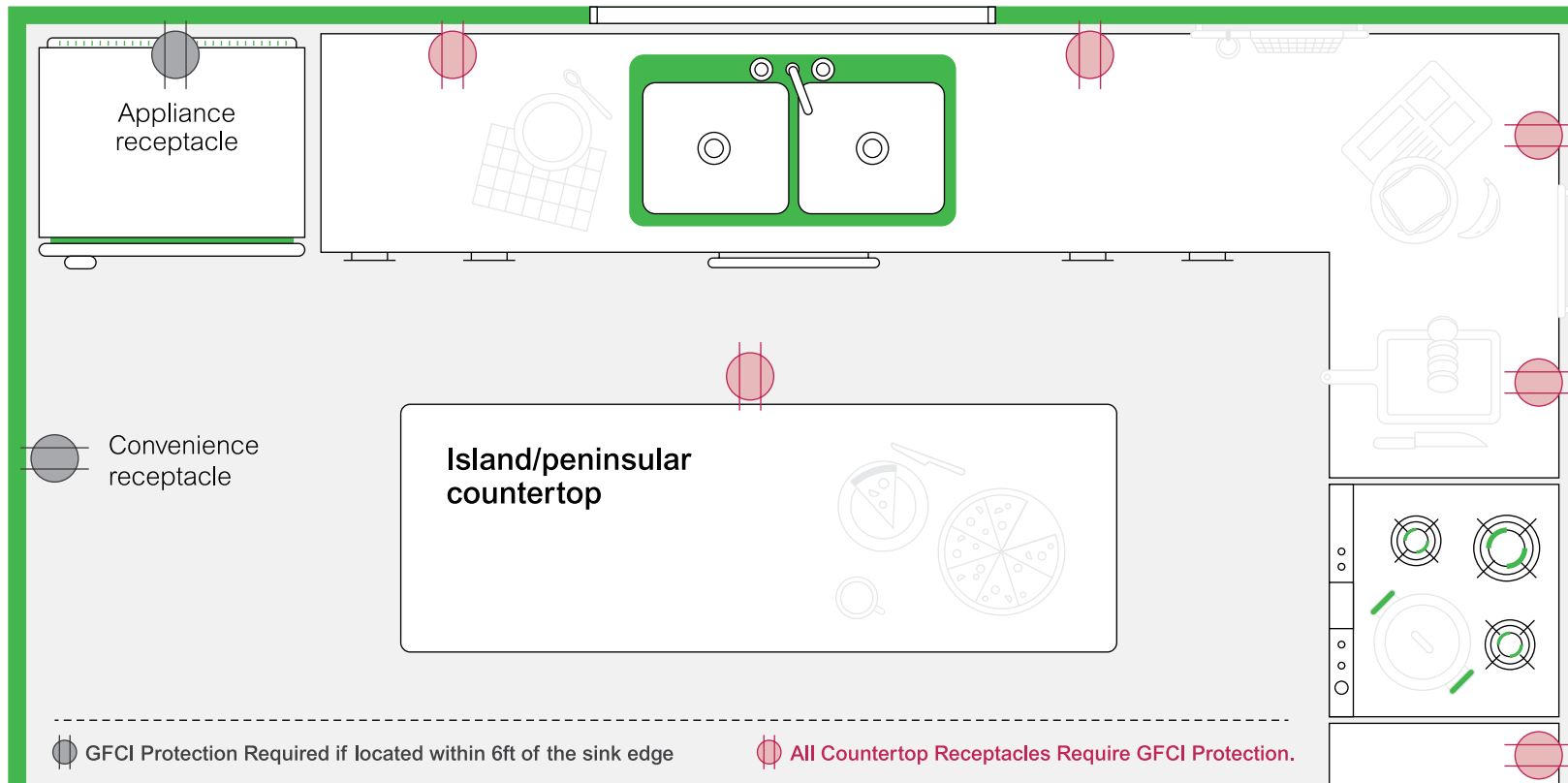

Now, let's move to updates affecting residential service equipment.

## CHAPTER 4

# Services

In this chapter, we dive into updates for service equipment, including arc energy reduction and surge protection.

## Power Distribution Blocks Service markings

The code now requires any devices used to splice service conductors to be listed. Power Distribution Blocks must be marked “**suitable for use on the line side of the service equipment,**” or with equivalent wording.

This marking requirement is effective on January 1, 2023.

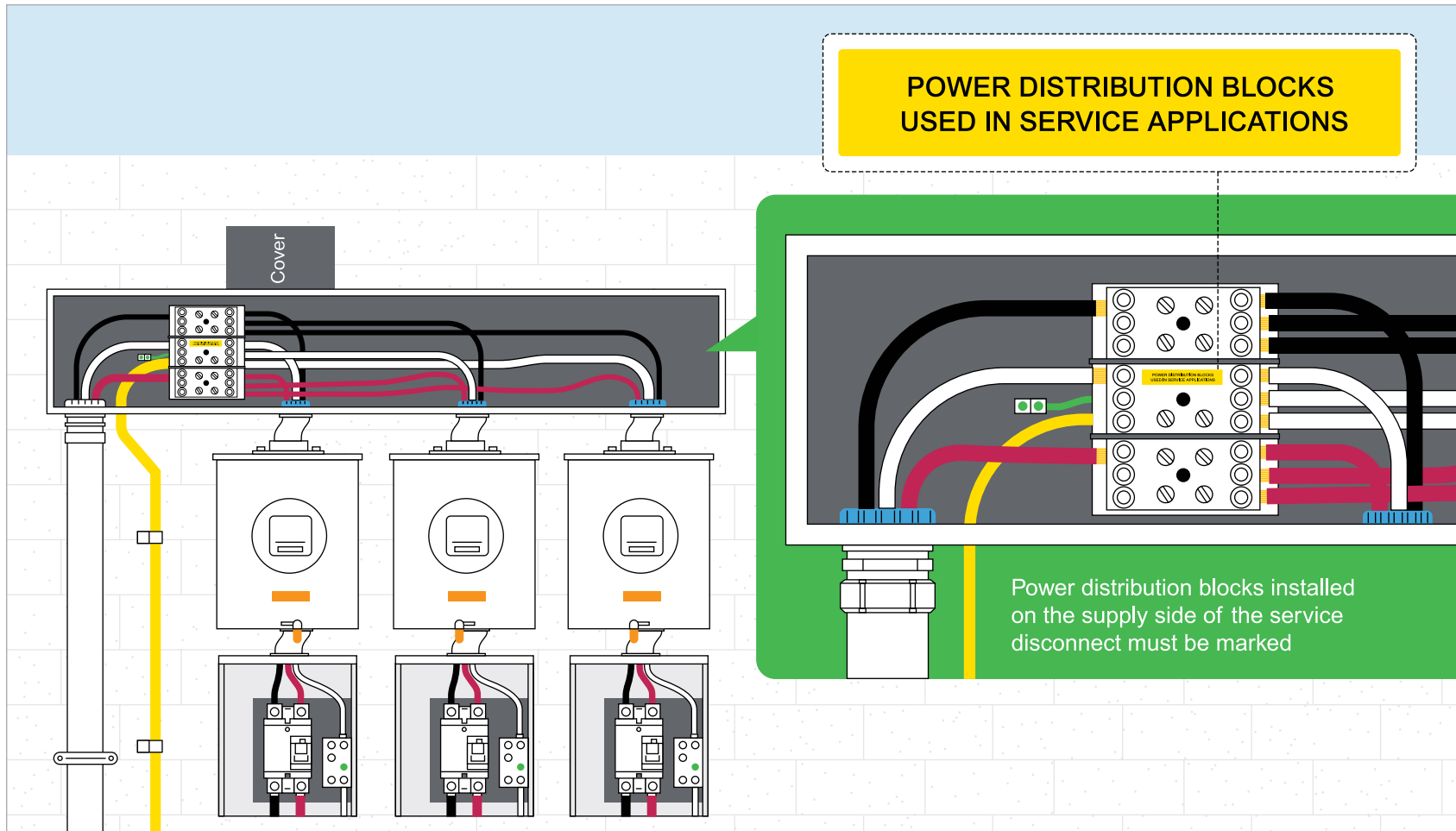

# Services

## Line-side barriers

Another important change for service disconnects is the expansion of line side barriers for all service disconnects. These barriers provide enhanced protection from inadvertent contact on the line side of service equipment.

This requirement has been in effect for panelboards, switchboards, and switchgear used as service equipment. However, subsection 230.62(C) now includes all service equipment, including service-rated transfer switches, safety switches, and enclosed circuit breakers.

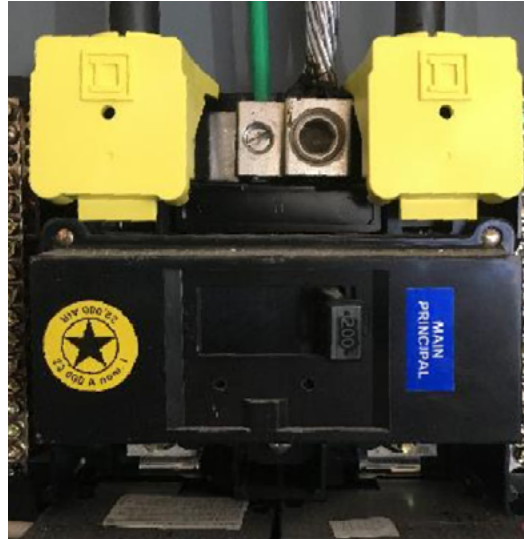

## Surge protection

Section 230.67 now requires either a Type 1 or Type 2 surge protection device for all services supplying dwelling units.

Surge protection is designed to protect equipment clamping overvoltages and by diverting or limiting surge current.

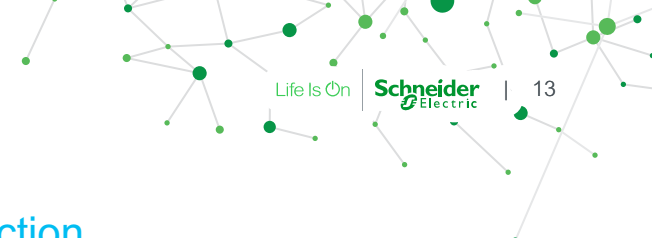

# Services

## Arc energy reduction

Section 240.67 and section 240.87 require all circuit breakers and fuses rated 1200 amperes or higher have a tripping level less than the available arcing current.

Documentation demonstrating the chosen method operates below the available arcing current is required.

On-site “performance testing,” such as a primary injection test or another approved method in accordance with the manufacturer’s instructions, is also necessary. Test results must be documented.



# Services

## Number of disconnects

The 2020 NEC generally permits only one service disconnect for each service.

The rules for up to six sets of switches or circuit breakers (or a combination of these) have been significantly restricted to only one service disconnect per enclosure, except for metering centers where each disconnect is in a separate compartment or switchgear.

Specifically, a panelboard is now allowed only one service disconnect within its enclosure. Switchboards are allowed only one service disconnect in each vertical section, provided the vertical sections are separated by a barrier.

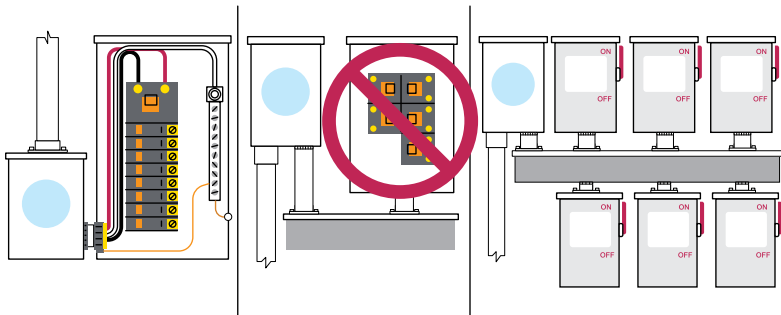

## Emergency disconnect

All one and two-family dwellings must now have an exterior emergency disconnect for fire service and first responder access per section 230.85. The disconnect may also serve as the service disconnect or a meter disconnect.

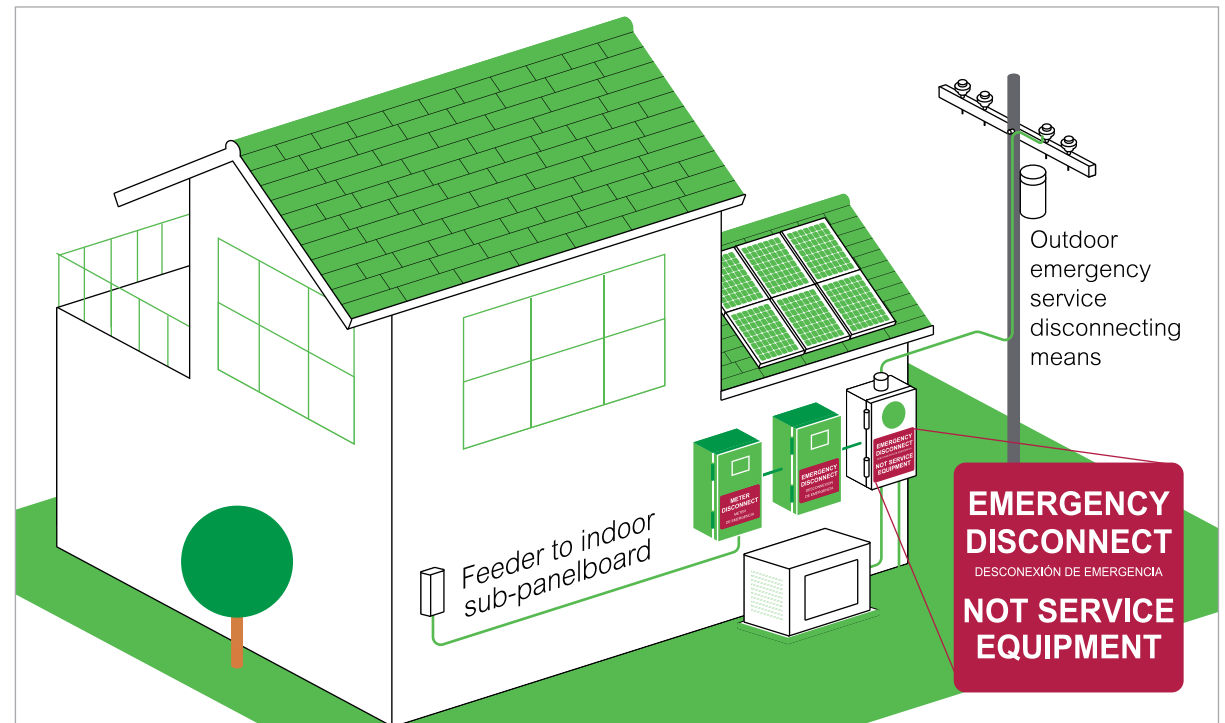

Let's now take a deeper look at the updated wiring and equipment calculations.

## CHAPTER 5

# Wiring and equipment calculations

In this chapter, we discuss how to calculate lighting loads, service ratings, volume allowance, etc.



# Wiring and equipment calculations

## Lighting loads

When calculating residential loads, section 220.53 allows for applying a demand factor of 75 percent to the nameplate rating load of four or more appliances rated one-quarter horsepower or greater, or 500 watts or greater, that are fastened in place. The revision in this section does not allow this demand factor to apply to:



Household electric cooking equipment that is fastened in place



Clothes dryers

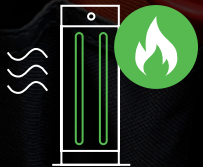

Space heating equipment



Air-conditioning equipment

## Service or feeder ratings

Section 310.12 includes a table referencing service or feeder ratings. This change improves code usability for contractors sizing services where no adjustment or correction factors are required.

A contractor can now find the service or feeder rating in the left-hand column and then read across to the appropriate column to identify the necessary conductor material and the minimum size service or feeder conductors allowed.

Table 310.12 Single-Phase Dwelling Services and Feeders		
Service or Feeder Rating (Amperes)	Conductor (AWG or kcmil)	
	Copper	Aluminum or Copper-Clad Aluminum
100	4	2
110	3	1
125	2	1/0
150	1	2/0
175	1/0	3/0
200	2/0	4/0
225	30/0	250
250	4/0	300
300	250	350
350	350	500
400	400	600



**Note:** If no adjustment or correction factors are required, this table shall be permitted to be applied.

# Wiring and equipment calculations

## Equipment grounding conductor (EGC) exception

Section 314.16 of the 2020 code eliminates the need for adding the volume allowance of the additional EGC. If more than four EGCs or bonding jumpers enter the box, take a one-quarter volume allowance for each EGC above four.

## Volume allowance

Each conductor is assigned a volume allowance based on the conductor size shown in table 314.16(B).

The 2020 NEC revises how the volume allowance is calculated based on the number of and size of equipment grounding conductors or bonding jumpers entering the box.

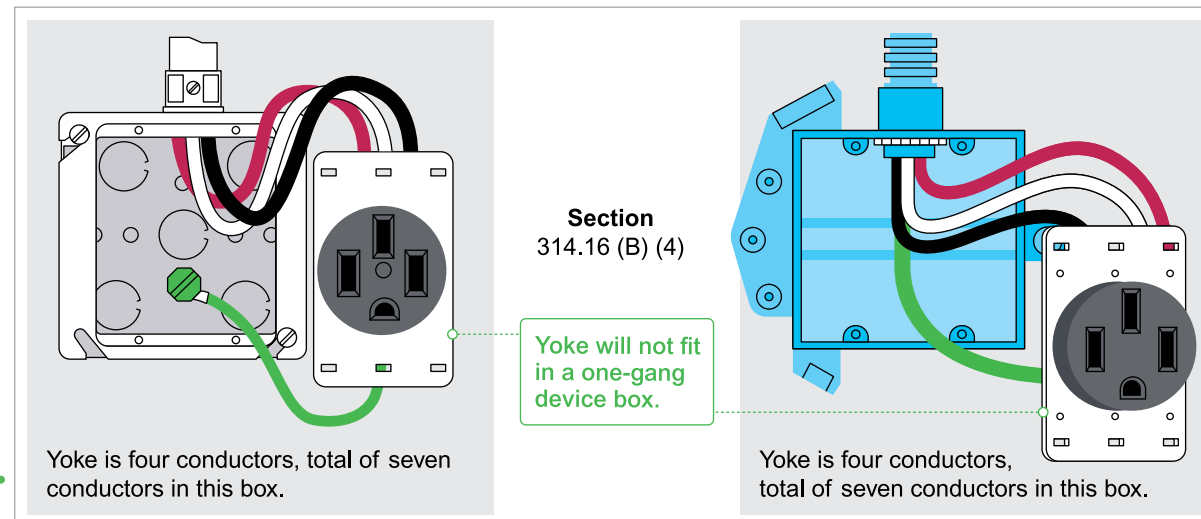

## Ceiling outlet boxes

Subsection 314.27(C) now requires outlet boxes or outlet box systems used to support ceiling-suspended (paddle) fans to be listed and marked by the manufacturer as suitable for this purpose, and shall not support fans weighing more than 70 pounds.

Outlet boxes designed to support ceiling-suspended (paddle) fans over 35 pounds must include a marking designating the maximum weight.

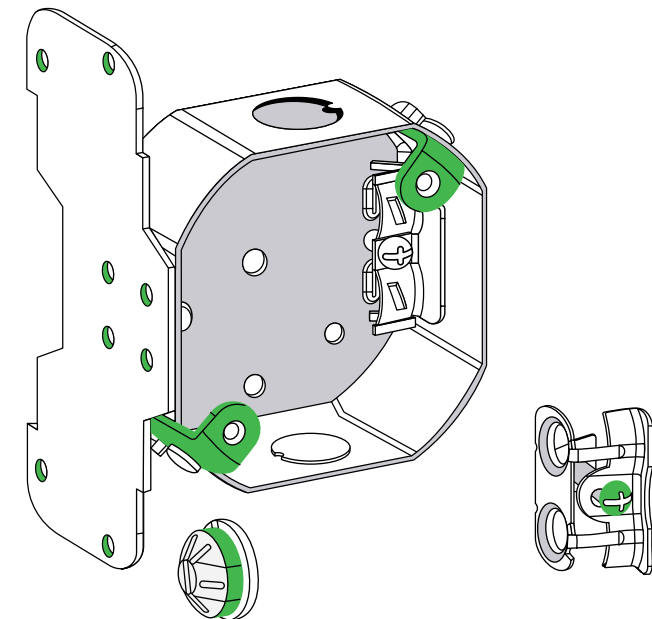

# Additional changes

## 406.5(G)(2)

A new requirement in subsection 406.5(G)(2) prohibits receptacles from being installed in the face-up position underneath a sink.

## 406.9(C)

Subsection 406.9(C) establishes a receptacle free area of three feet horizontally and eight feet vertically from the top rim of a bathtub or shower stall. An exception is provided for bathrooms that cannot meet the new zone requirement.

## 406.12

Section 406.12 requires tamper-resistant receptacles in attached and detached garages, accessory buildings, and common areas of multi-family dwellings.

---

Finally, let's wrap up with these final tips to boost your NEC expertise.

## 408.4

Section 408.4 allows circuit directories for panelboards to be in an approved location adjacent to the panelboard.

## 410.69

Effective January 1, 2022, lighting control conductors can't be the same color as the grounded or equipment grounding conductor at the luminaire. See section 410.69.

## 422.16(B)(2)

Subsection 422.16(B)(2) requires a bushing, grommet, or other approved means of protection for flexible cords passing through a hole from the space holding a dishwasher or trash compactor to the space containing the receptacle.

## CHAPTER 6

# Next steps

Review these final tips to boost your NEC expertise.

Next steps

# Here are some final tips to boost your NEC expertise

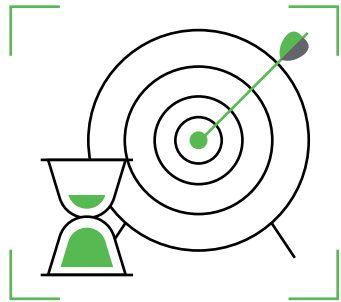

Know when your jurisdiction will adopt the 2020 NEC

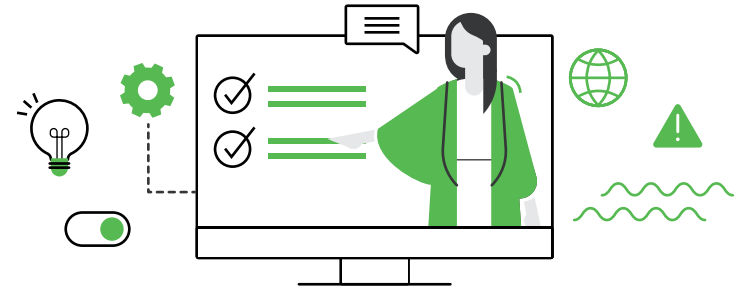

Take advantage of NEC training opportunities, including in-person seminars, workshops, online training modules, and webinars. Be sure the opportunities support your CEU requirements for license renewal.



Consult manufacturers' websites, which are often a valuable resource for code update information.

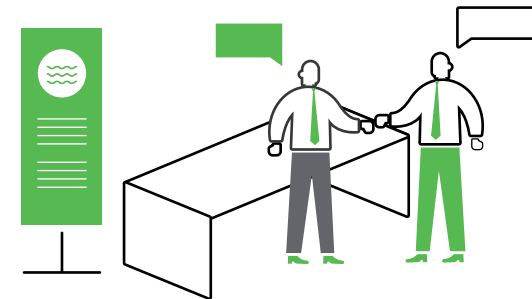

Network through association meetings and conferences to learn additional best practices.

**Above all, have a plan for implementing the 2020 NEC.**

Next steps

# For more insights, sign up for the Electrical Contractor Portal.

After registering, you will gain access to exclusive resources, including:

- Live and on-demand trainings
- Application and technical information for products and solutions
- Contractor Rewards Program
- Support
- And more...



[se.com/us/contractors-register](https://se.com/us/contractors-register)

